



TELECOM REGULATORY AUTHORITY OF INDIA

**Recommendations
on
Provision of IPTV Services**

28th November 2007

**Mahanagar Doorsanchar Bhawan
Jawahar Lal Nehru Marg
New Delhi-110002**

INDEX

	Preface	2
Chapter 1	Introduction	4
Chapter 2	Operations of IPTV Network	6
Chapter 3	Regulatory Issues	12
Chapter 4	Summary of Recommendations	30
Annexure-I	International Experience	33
Annexure-II	Gist of Stakeholders' comments	37

PREFACE

Provision of the television channels using high speed Internet protocol (IP) technology is normally called as IPTV. It is fast becoming popular value added service in many countries. This is a new method of delivering and viewing television programs.

The provisioning of IPTV services has been engaging attention of TRAI as presently there is lack of clarity. After due deliberations with stakeholders Authority felt that in-depth analysis is required to address the issues related to provision of IPTV services. Some of these are:

- a) Technological requirement of IPTV services to deliver content through a Set Top Box (STB) may lead to non-compliance of Cable Television Networks (Regulation) Act, 1995 in reference to delivery of Free-To-Air channels without needing an addressable system.
- b) Use of different devices by different service providers and lack of standardization for IPTV set top box may violate the Cable Television Networks (Regulations) Act, 1995 in reference to use of equipment conforming to Indian Standards.
- c) Applicability of FDI norms, downlinking guidelines and programme codes on Unified Access Services licensees licensed under Telegraph Act providing IPTV services.

The Authority has deliberated at length on all the relevant issues and has come out with a position paper on 6th September 2007. This paper analysed various methods to provide IPTV and the associated regulatory issues with the objective of bringing clarity on various regulatory provisions and licensing requirements to encourage stakeholders to launch IPTV services as and when they so desire. Stakeholders were requested to submit comments by 21st September

2007. All the comments received have been analysed.

While framing these recommendations, due consideration has been given to stakeholders' comments and best international practices. In line with the Authority's consultative approach and acknowledging the importance of the subject, the draft recommendations are being put up on TRAI's website. Any stakeholder can send its comments to Advisor (CN), Mr. S. K. Gupta on e-mail guptask61@gmail.com or skgupta@trai.gov.in by 6th Dec 2007. Recommendations thereafter will be finalized and sent to Government for taking necessary action.

(Nripendra Misra)
Chairman, TRAI

CHAPTER 1

INTRODUCTION

1.1 Background

- 1.1.1 The issue of IPTV came up during discussions on consultation paper on “Convergence and Competition in Broadcasting and Telecommunication” during January 2006. The various issues related with the provisioning of IPTV were examined and an amendment in Cable Television Network (Regulation) Act 1995 was proposed.
- 1.1.2 However on further discussions with various stakeholders it was felt that some additional analysis is needed and accordingly, the proposed draft modification in the Cable Television Networks (Regulation) Act 1995 was withdrawn.
- 1.1.3 The Authority analyzed various issues raised during discussion and identified certain grey areas regarding provision of IPTV. A letter highlighting grey areas was sent to Ministry of Telecommunications as well as to Ministry of Information and Broadcasting for their consideration so as to bring clarity on the issue. Subsequently, a core group was formed by the concerned ministries to look into the issues regarding provision of IPTV and give its recommendations.
- 1.1.4 In the meantime, the Authority deliberated the whole issue of provisioning of IPTV by telecom operators and cable operators and issued a position paper on IPTV, which analysed various methods to provide IPTV and associated regulatory issues to bring clarity on regulatory provisions and licensing requirements.

1.1.5 In line with the Authority's consultative approach, TRAI obtained comments of the stakeholders on the position paper before finalizing the recommendations. The Authority deliberated on various issues emanating from the written submissions of the stakeholders and International practices. The Comments of stakeholders have been compiled and are given at annexure II. The recommendations have been structured in chapters' two to four. Chapter 2 on "Operations of IPTV Network" deals with technical details of IPTV services. Chapter 3 on "Regulatory Issues" analyses various issues regarding provisioning of IPTV service including content regulation, non discriminatory provisioning of content to IPTV service providers. Chapter 4 is compilation of recommendations on IPTV.

CHAPTER 2

Operations of IPTV Network

- 2.1 The fast development in telecommunication technologies, enormous capabilities of Internet protocol (IP) platform and increasing digitalization in broadcasting sector is driving services like Internet Protocol TV (IPTV), video on demand etc.
- 2.2 IPTV service is provided by an operator using controlled platform in which the consumer directly interacts with equipments installed by operator in closed user group. IPTV system delivers digital television service using Internet Protocol (IP) over various access technologies supporting high speed Internet like broadband connection based on copper loop, optical fiber or wireless access technologies etc. IPTV platform can also provide services like Video on Demand (VoD), Live Video and gaming etc. Since triple play services encompass Voice, Video and data, IPTV is also considered within umbrella of triple play services.

2.3 Architecture of IPTV operation in telecom network :

Figure 1 illustrates the basic components of a typical IPTV operational setup.

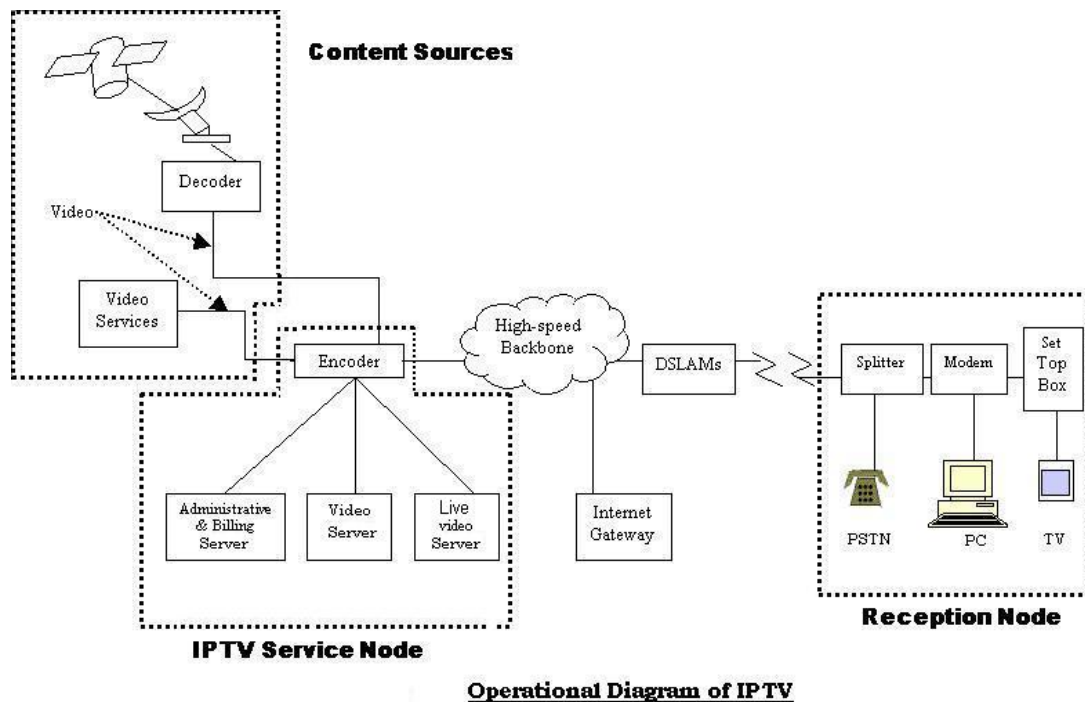

Fig. 1 Operational Diagram of IPTV

i) Encoding: The IPTV encoder receives video streams in different formats from different sources. Typically the videos are received from either broadcasters using satellite receptions or from stand-alone video content producers. The IPTV providers can also create their own video contents. These video streams, are then re-formatted and encapsulated for further transmission using Internet Protocol with appropriate Quality of Service (QoS). This makes it ready for delivery to customers. The combination of IPTV encoder, Administrative & Billing Server, VoD server and Live Video server is collectively known as **IPTV Service Platform**. The Customers interact with administrative and billing server for authorization and subsequent delivery of various IPTV channels, video-on-demand (VoD) and other live contents based on package selected.

IPTV service can provide Live TV, time shifted TV and VoD after code conversion and encryption. Typically, the live video content is delivered in Moving Pictures Expert Group Version-2 (MPEG-2) format using IP multicast. This is a method in which information can be sent to multiple computers simultaneously. Newly released H.264 format is pre-designed to replace the older MPEG-2. In standard-based IPTV systems, Internet Group Management Protocol (IGMP) and Real Time Streaming Protocol (RTSP) are used. Here, IGMP version 2 is used for channel change, signaling etc for Live TV viewing and RTSP is used for stored services like VoD.

ii) Digital Subscriber Line Access Multiplexer (DSLAMs):

DSLAM is equipment used to deliver high-speed IP packets over Copper loop media to the subscriber in telecom network. The various video contents after getting encoded as per Internet Protocol are handed over to DSLAM, if such signals are to be delivered to the subscribers using telephone local loop copper line. These DSLAMs can either be co-located with the IPTV service node (normally called Headend) or can be located far away and connected using high-speed backbone network. The DSLAMs receive voice service signal from MDF of exchange for voice calls and video signal from IPTV Headend. DSLAM combines these signals and sends it on copper loop to the subscriber premises using telephone network.

iii) Reception Mechanism: In DSL both voice and data signals are carried over copper loop. At subscriber premises copper loop is connected to splitter which separates the voice service signal & data. The voice output is connected to telephone set and the video output of the splitter is connected

to a device called multi port modem also known as Customer Premises Equipment (CPE). A personal computer (PC) & set-top box can be simultaneously connected with the CPE on different ports to receive Internet and IPTV respectively. For IPTV reception TV is directly connected to the set top box. This is depicted in Figure 2

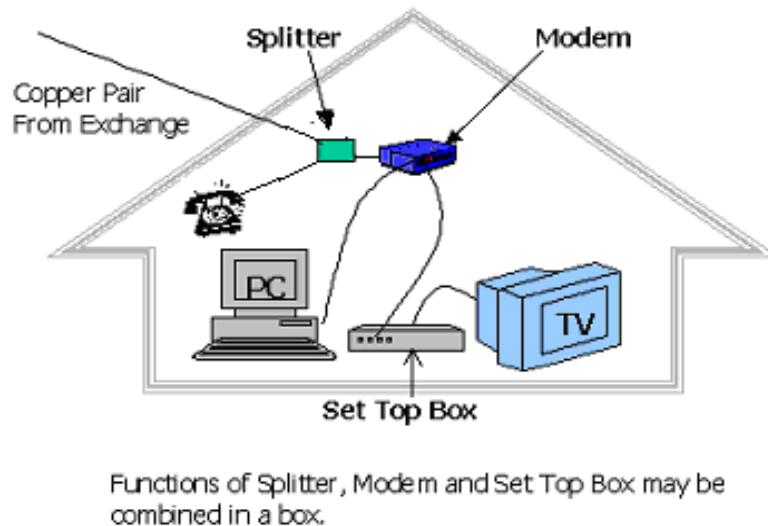

Fig. 2

The set top box processes the received signal and delivers it to TV in compatible form. The interaction with central administrative and billing server, as well as DSLAM to select an IPTV channel is done by set-top box. IPTV viewers will have full control over functionality such as rewind, fast-forward, pause and so on by interacting with the video server for non-live programs. Various applications like Time shifted TV, video gaming etc are possible using IPTV platform.

2.4 Provision of IPTV over Cable TV networks :

It is possible to provide IPTV over cable TV networks using cable modem technologies like Data over Cable Service Interface Specifications (DOCSIS), which permits two way

communications in cable network. The present cable modem technologies (EuroDocsis 1.0/1.1/2.0) have ample capacity still applications like IPTV, video-on-demand may require high bandwidth. Next-generation technologies (Docsis 3.0) will make it possible to increase capacity at a reasonable cost. The PacketCable QoS feature of cable modems is also available in Docsis 3.0.

In implementation of IPTV, cable operators can utilize their transmission infrastructure, customer resource manager (CRM) and invoicing system.

The transmission network of cable operator (If designed to support two way operation) can carry all three types of signals (IP, digital TV and analogue TV) simultaneously. A subscriber can receive analogue cable TV without requiring any STB or cable modem. Such subscriber if so desire can simultaneously use cable modem for broadband services by using one-to-two splitter as shown in fig. 3. IPTV can also be provided on such networks by using IP TV set top box.

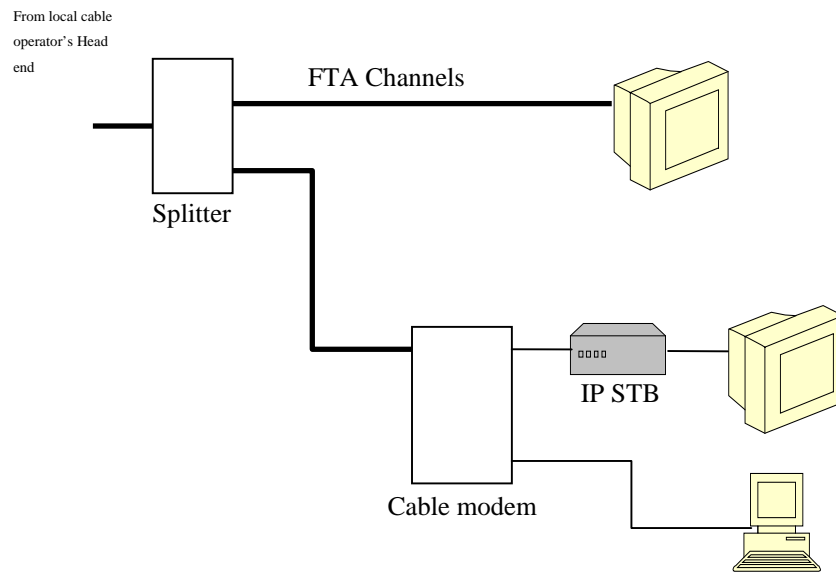

Fig. 3 Provision of IPTV over Cable network

CHAPTER 3

Regulatory Issues

3.1 Provisioning of IPTV Service:

3.1.1 As per ITU, IPTV is defined as multimedia service such as television/video/audio/text/graphics/data delivered over IP based networks managed to support the required level of QoS/QoE, security, Interactivity, and reliability. In simple terms, provision of television signal using Internet Protocol for transmission of signals to the subscribers is termed as IPTV. Since telecom service providers having Unified Access Services license (UASL) and Cellular Mobile Telephony Service (CMTS) License are permitted to provide triple play service, they can also provide IPTV services as it is within ambit of triple play services. ISPs having net worth of more than Rs.100 crores are especially permitted to provide IPTV services after obtaining permission from the licensor. The question was being raised time and again in view of the provision of Cable Television Network (Regulation) Act 1995 whether these operators needed any other regulatory clearances or registration to provide IPTV to their subscribers. It will be important to mention that Cable Television Network (Regulation) Act 1995 provides that no person shall operate a cable television network unless he is registered as a cable operator under this act.

3.1.2 The issue of IPTV came up for discussion during discussions on consultation paper on “Convergence and Competition in Broadcasting in Telecommunication” issued on 2nd January, 2006. One school of thought was that as IPTV is a closed transmission path designed to provide cable TV services, therefore it should be governed by the provisions of ‘Cable

Television Network (Regulation) Act 1995'. However the other school of thought was that there will be certain grey areas/ issues if IPTV service is governed by the existing Cable Television Network (Regulation) Act, 1995. The issues which needed further clarity are: -

- i) Technological requirement of IPTV to deliver content through a STB leads to non-compliance with the requirement of Section 4A of Cable Television Networks (Regulation) Act, 1995 about Free-To-Air channels not needing an addressable system in CAS notified areas.
- ii) Use of different protocols by different companies and lack of standardization for IPTV services may violate the requirement of Section 9 of Cable Television Networks (Regulation) Act, 1995 about use of equipment conforming to Indian Standards.
- iii) Applicability of FDI norms, downlinking guidelines and programme codes on telecom operators licensed under Telegraph Act providing IPTV services with same content as Cable TV needs clarification.

3.1.3 The important issue is to determine if IPTV provided by Telecom operators is Cable Television network as first two issues are pertinent only when it is assumed that IPTV service provided by telecom operators constitutes cable services and is covered under the ambit of Cable Television Network (Regulation) Act 1995. In order to understand its applicability, it is important to examine various definitions given in this Act.

3.1.4 "Cable Television Network" means any system consisting of a set of closed transmission paths and associated signal generation, control and distribution equipment, designed to

provide cable service for reception by multiple subscribers.

3.1.5 “Cable Services” means the transmission by cables of programmes including re-transmission by cables of any broadcast television signals.

3.1.6 “Programme” means any television broadcast and includes:-

- i) exhibition of films, features, dramas, advertisements and serials through video cassette recorders or video cassette players;
- ii) any audio or visual or audio-visual live performance or presentation.

3.1.7 “Company” means a company as defined in section 3 of the Companies Act, 1956.

3.1.8 “Person” means:

- i) an individual who is a citizen of India;
- ii) an association of individuals or body of individuals, whether incorporated or not, whose members are citizens of India;
- iii) a company in which not less than fifty one per cent of the paid up share capital is held by the citizens of India.

3.1.9 As has been discussed in Chapter 2, IPTV network consists of closed transmission paths and associated signals. However, network setup of telecom operators is designed to provide telecom services and not a cable service. IPTV service can be delivered using Telecom network local loop, optical fiber or wireless media. Hence delivery of IPTV signal in a Telecom network is not restricted to telecom local loop but also includes wireless media, Optical fiber etc. When the issue is to determine whether IPTV is a “Cable Service” or not, it will defy logic if it is said that IPTV delivered through wireline using

telecom local loop would be a cable service but the same IPTV delivered through wireless is not a cable service. Indeed there may be situation where the IPTV service provider delivers IPTV service to subscribers' home using a combination of wireline and wireless media. Hence delivery of such signals cannot be termed uniformly as delivery through cable. Therefore IPTV service provided by telecom operators is not the same as "cable service".

3.1.10 Secondly, the cable Television network is defined as one ".. designed to provide cable services for reception by multiple subscribers". In IPTV, subscribers communicate individually to the central equipment as well as DSLAM. The individual local loop carries individual TV signal for individual subscriber. That is to say, the telecom local loop carries, at a time, only one TV channel which has been "pulled" out by individual subscriber from IPTV server or DSLAM on "One-to-One" basis, as against the conventional cable TV network which carries all the channels at any time because these channels have been "Pushed" by the local cable operator into the cable TV network on "One-to-many" basis by multiple subscribers. Therefore in telecom network TV signal is delivered from a central node (DSLAM) to individual subscriber over a separate dedicated line and not to multiple subscribers. However, a single channel/video can be viewed by multiple subscribers connected to same node through its own dedicated path. Hence, again IPTV is not the same Cable Television Network service. This is amply clear from figures 4(a) and 4(b) given below.

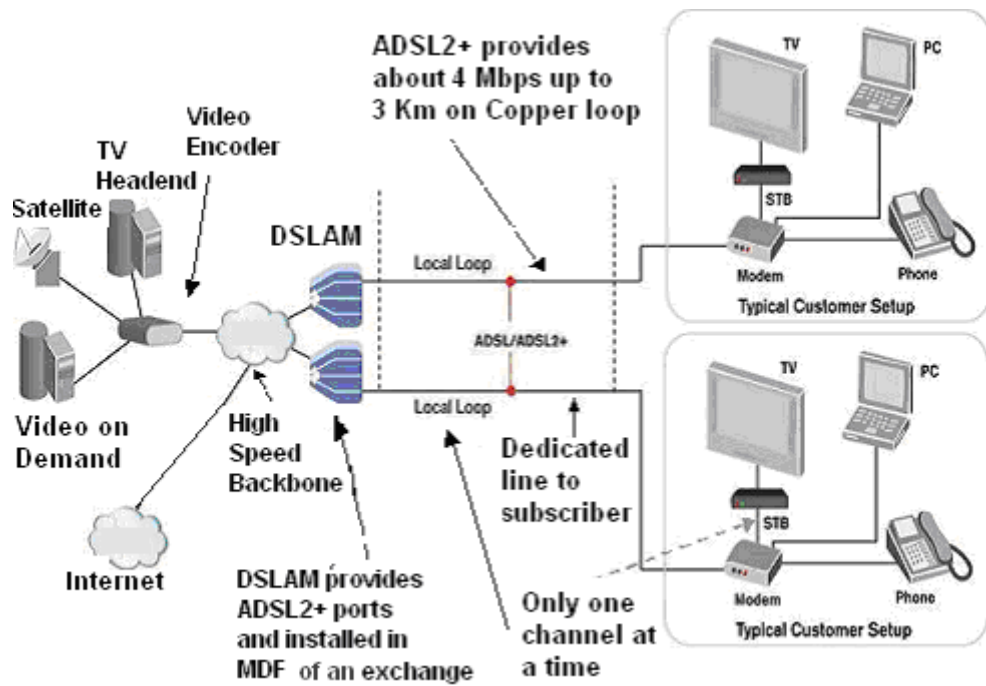

Diagram 4(a.1): Internet Protocol Television over DSL

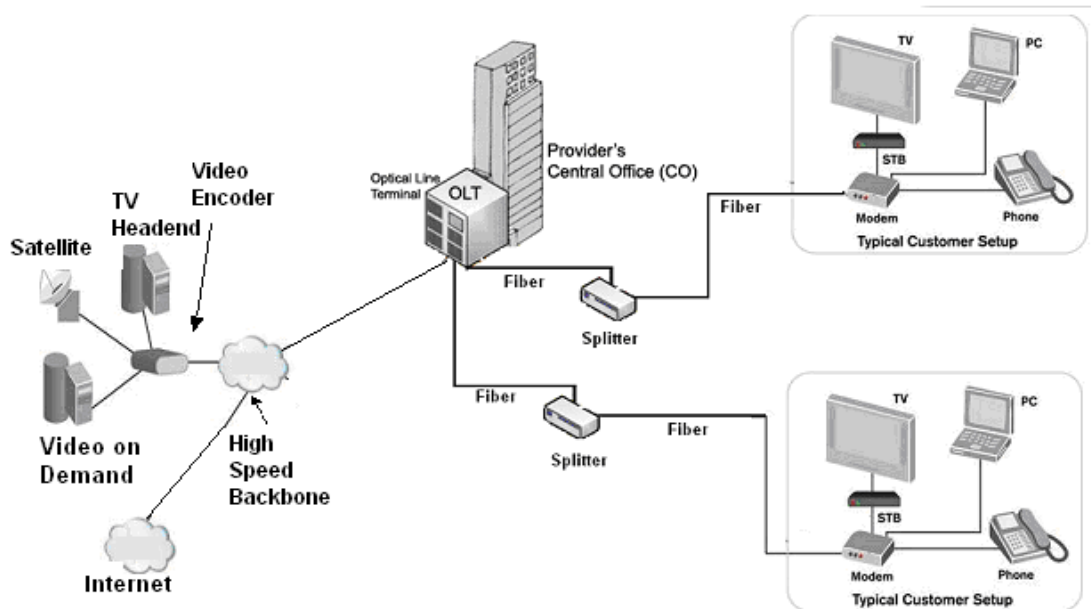

Diagram 4(a.2): Internet Protocol Television over Fiber

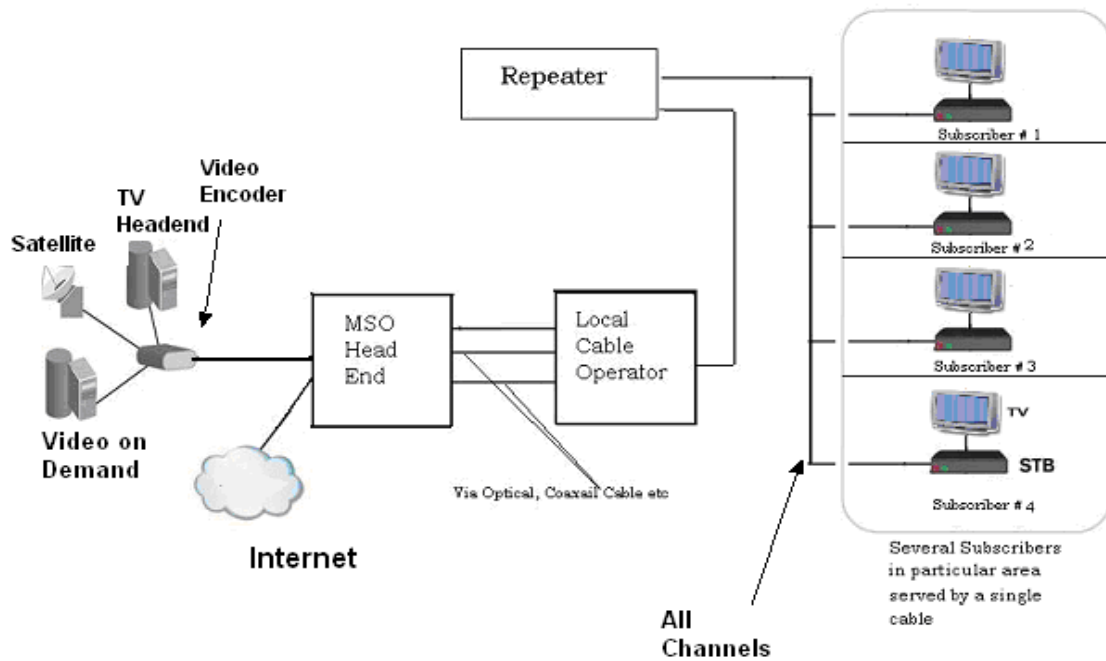

Diagram 4(b) : Traditional Cable TV service Network

3.1.11 Further analysis of the cable networks and IPTV networks indicate that both the structures are grossly different. In case of cable network, all the channels are pushed to the subscriber premises and are available at set top box (STB) and can be viewed based on the authorization given to the subscriber as per service subscribed by him. All channels are available in encrypted form at set top box even if it is not switched on. The scenario in case of IPTV is completely different. As soon as STB is switched on, it talks to central administration and billing server and receive authorization as per the preferences given by the subscriber. Such authorization details remain with STB till it is kept switched on. The TV signals are available at different points in the network based on the medium used to provide IPTV. In case of

DSLAM, TV channels are generally available up to DSLAM level. However, in case of optical fiber media, it can be made available up to Set top box also but only those TV channels are accessible which are permitted as per authorization. Based on this authorization, it can fetch TV signals either from DSLAM or any other point in the networks. Since in this technology authorization information and channel are pulled from network, it is also called as pull type technology which first request for authorization privileges based on which TV channels can be viewed. The above discussions clearly indicate that IPTV networks are two-way interactive networks in contrast to conventional cable TV, which are generally one way at present.

3.1.12 Let us now consider the delivery of channels in IPTV technology. The specific channel in this technology is transmitted on a dedicated line to individual subscriber, which is displayed on subscriber's TV. Effectively such networks cater for individual subscribers request through dedicated local loop and such programmes are not received simultaneously by the multiple subscribers on single telephone local loop.

3.1.13 The methodology of providing particular service is also important and requires examination while assigning applicability of Cable Television Networks (Regulation) Act 1995. This regulation applies to provision of TV signals using cable television network. IPTV when provided using telecom network is different than the services envisaged under Cable Television Network (Regulation) Act 1995.

3.1.14 From the above discussion it can be inferred that Cable Television Networks (Regulation) Act 1995 does not apply to provision of IPTV services through telecom network and has to

be regulated under appropriate license of service provider under Indian Telegraph Act 1885. **Telecom service providers as defined in clause 3.1.1 can therefore provide IPTV services without any other registration under their license.**

3.1.15 Questions are also raised whether Cable TV operators can provide IPTV services without violating provisions of clause number 4(A) 6 of Cable television Network (Regulation) Act 1995. In order to bring clarity it is important to deliberate the issue.

3.1.16 Generally, the cable TV operators provide live feed of all the channels up to subscriber premises and subscribers can select the required channel in addressable mode. Internet protocol is not necessary for this type of service which is being provided at present. Further in this case no modifications in the contents are permitted/ possible. Cable television operators already have a functioning television service distribution system in place, and the implementation of IPTV would require new investments even to provide the existing TV channels to the customers. In case the cable operators want to provide Video on demand (VoD), time shifted TV, and other interactive services, then only they may build IPTV setup. The provision of TV signals using Internet Protocol on cable network is not prohibited. Any cable operator, if so desires can always provide Cable TV Service using Internet Protocol in his network without requiring any telecom license, as his registration under “Cable Television Network (Regulation) Act 1995” permits him to provide cable TV service but does not regulate the technology for providing such services. Also, as discussed in chapter 3, a cable operator providing IPTV service is capable to provide Free-to-Air channels without STB, which will fulfill the condition 4(A) of Cable TV Act. **Therefore Cable TV**

operator can provide IPTV services without requiring any additional license.

3.1.17 Concerns have also been raised whether cable TV operators who wish to provide IPTV service will violate the provisions of clause 9 of Cable Television Networks (Regulation) Act 1995? The clause is reproduced below for quick reference:

“Use of standard equipment in cable Television network :

No cable operator shall, on and from the date of the expiry of a period of three years from the date of the establishment and publication of the Indian Standard by the Bureau of Indian Standards in accordance with the provisions of the Bureau of Indian Standards Act, 1986 (63 of 1986), use any equipment in his cable television network unless such equipment conforms to the said Indian Standard.

PROVIDED that the equipment required for the proposes of section 4A shall be installed by cable operator in his cable television network within six months from the date, specified in the notification issued under sub-section (1) of that section, in accordance with the provisions of the said Act for said purposes.”

Bureau of Indian Standards (BIS) have not yet defined any specifications for IPTV Set Top Box. Clause 9 emphasises use of equipments standardized by BIS in cable television network however, does not explicitly prohibits any element/device/equipment not standardized by BIS. Therefore till BIS comes out with IPTV Set Top Box specifications, cable operators will be within their rights to provide IPTV using existing set top boxes. **BIS may also be requested to look into it and expedite standardization of IPTV Set Top Box specifications to help cable operators while designing their IPTV networks.**

3.1.18 Some of the stakeholders suggested that there should be separate license for IPTV services, as administering the same service provided by two different sets of players by two different regulators is a cumbersome task. The service should be brought under single legislation and be administered by single agency for effective moderation. Here it is important to mention that in the era of convergence defining service specific licenses will be a very narrow vision and will throttle the advantage of convergence.

3.1.19 The phenomenon of “Convergence” is the driver in the triad-technology market and policy. In span of about 12 years, radical advances in technology, market institutions, forward looking government policies and regulatory policy backed with sinews of competition have transformed telecommunication sector. The need of the hour is to have a regulatory framework that foster innovation, investment and affordable access. Any forward looking analysis in the context of ongoing convergence must be technologically neutral, given the type of dynamic changes that may result from future delivery of services based on different technologies.

3.1.20 IPTV service is neutral to access network. It is considered as content delivery service over carriage networks governed by their respective Acts/ licenses. It can be provided by the telecom operators using telecom network as well as cable operators using cable network. **The carriage of IPTV, if it is carried and delivered by a telecom service provider, will have to be regulated under appropriate telecom license and if it is carried and delivered by a cable TV operator, then it will have to be regulated under Cable Television Network (Regulation) Act 1995.** Concerns have been raised regarding area of operation. Since carriage is being regulated

under specific license/ registration, the area of operation will also be the same as defined in such licenses/registration. Accordingly any violation/breach of the provisions of the respective Acts/ License/ Registration/ Permissions by IPTV service providers will have to be dealt by designated agencies which are responsible for administering such Acts/ License/ Registration/ Permissions.

3.1.21 **Recommendations,**

The Authority recommends,

- i) Telecom service providers (UASL, CMTS) having license to provide triple play services and ISPs with net worth more than Rs. 100 Crores and having permission from the licensor to provide IPTV can provide IPTV service under their licenses without requiring any further registration. Similarly cable TV operators registered under Cable Television Network (Regulation) Act 1995 can provide IPTV service without requiring any further license.**
- ii) Any breach of the provisions of Act/ License/ Registration/ Permission by telecom service provider/ cable operator/ Broadcasters shall be dealt with by designated agencies which are responsible for administering such Acts/ License/ Registration/ Permissions.**
- iii) BIS may also be requested to look into it and expedite standardization of IPTV Set Top Box specifications to help cable operators while designing their IPTV networks.**

3.2 Content regulation:

3.2.1 We now come to an important issue relating to regulation of content. As far as the cable operator is concerned, he is bound by the provisions of clauses 5 and 6 of the Cable Television Network (Regulation) Act 1995, which relate to program code and advertisement code (reproduced below):

“ 5. Programme code :

No person shall transmit or re-transmit through a cable service any programme unless such programme is in conformity with the prescribed programme code:

6. Advertisement code :

No person shall transmit or re-transmit through a cable service any advertisement unless such advertisement is in conformity with the prescribed advertisement code:”

However, since telecom service providers providing IPTV service will not be covered by Cable Television Network (Regulation) Act 1995 as already discussed, content regulation becomes an important issue. Here it is important to note that neither Telegraph Act nor licensing conditions of telecom operators permitted to provide triple play services or IPTV service prescribe any specific provisions for content regulation. Therefore, it becomes necessary to have appropriate formulation in place in this regard.

3.2.2 Generally IPTV provider can get TV channels only from broadcasters. Broadcasters are already bound by the up-linking/ down-linking guidelines. Therefore as long as such IPTV operators provide only those channels which already have up-linking/ down-linking permission there will be no issue relating to the content regulation. Telecom service provider providing IPTV will not be responsible for such content and responsibility will completely rest with

broadcaster providing such contents.

3.2.3 The other scenario could be where IPTV providers may also provide content other than TV channels from broadcasters like video on demand, music-on-demand, and games or locally developed content etc. In such cases the telecom licensee shall be responsible for observing program code and advertisement code and such program code and advertisement code shall be the same as provided in Cable Television Network (Regulation) Act 1995 and Rules thereunder. The above stated contents can broadly be classified as broadcasting content, Internet related content or video on demand including movie related content. Ministry of Information and Broadcasting is monitoring content related to broadcasting and Movie whereas IT ministry is monitoring the contents related to Internet. It would therefore be appropriate that respective ministries regulate the content provided using IPTV platform. Operational procedures like time to keep a copy of the contents shown on IPTV, monitoring requirements etc can be worked out by DOT based on the feedback from respective ministries. Any violation of prevailing Acts/ Rules/ guidelines relating to content by telecom service providers in provisioning of IPTV service shall be reported to DoT by respective ministries. The decision of the respective ministries regarding violation of the law/ direction/ guidelines in respect to content shall be final. DoT may perhaps seek the guidance of the respective ministries to ascertain the penalties for the breach to maintain uniformity and shall initiate suitable action for imposing penalties for violations in time bound manner.

3.2.4 Concerns have been raised that Telecom service provider providing IPTV can also produce and show news channels, which is highly regulated and maximum FDI is limited to 26% in such sector. Hence they will be able to bypass present

provisions if IPTV service is permitted to telecom operators. The Authority has deliberated the issue and is of the opinion that **Telecom service provider providing IPTV will show only those new channels which are permitted by I & B Ministry.**

3.2.5 Considering above discussions and to ensure that unregulated content are not shown by Telecom service provider providing IPTV service, suitable provisions will have to be specified in respective licenses of Telecom service providers.

3.2.6 **Recommendations,**

The Authority recommends,

- (i) **Telecom licensees while providing TV channels through IPTV shall transmit only such channels in exactly same form (unaltered) for which broadcasters have received up-linking/down-linking permission from Government of India (Ministry of Information and Broadcasting). In such cases, the responsibility to ensure that content is in accordance with the extant laws, rules, regulations etc shall be that of the broadcaster and telecom licensee will not be held responsible.**
- (ii) **In case of contents other than TV Channels from broadcasters, the telecom licensee shall be responsible for observing program code and advertisement code and such program code and advertisement code shall be the same as provided in Cable Television Network (Regulation) Act 1995 and Rules thereunder.**
- (iii) **I & B Ministry and IT ministry are monitoring the contents related to their jurisdiction. It would therefore be appropriate that respective ministries regulate the**

content by using IPTV service providers. Operational procedures like time to keep a copy of the contents shown on IPTV, monitoring requirements etc can be worked out by DOT based on the feedback from respective ministries. Any violation of prevailing Acts/ Rules/ guidelines relating to content by telecom service providers in provisioning of IPTV service shall be reported to DoT by respective ministries. The decision of the respective ministries regarding violation of the law/ direction/ guidelines in respect to content shall be final. DoT may perhaps seek the guidance of the respective ministries to ascertain the penalties for the breach to maintain uniformity and shall initiate suitable action for imposing penalties for violations in time bound manner.

- (iv) Telecom service provider providing IPTV will show only those news channels which have been approved by I & B Ministry.**
- (v) Suitable modifications may be made in respective licenses of Telecom service providers to incorporate above provisions.**

3.3 Down linking Policy:

- 3.3.1 Concerns have also been raised that as per the provisions of policy guidelines for down-linking of television channels the broadcasters can provide Television Channel signal reception decoders only to MSOs/Cable Operators registered under the Cable Television Networks (Regulation) Act 1995 or to a DTH operators registered under the DTH guidelines issued by Government of India. Therefore, if IPTV is not a cable service, then such signals cannot be provided by the broadcasters to IPTV service providers. The clause No.5.6 of down linking

guidelines is reproduced below:

“The applicant company shall provide Satellite Television Channel signal reception decoders only to MSOs/Cable Operators registered under the Cable Television Networks (Regulation) Act 1995 or to a DTH operators registered under the DTH guidelines issued by Government of India”.

3.3.2 IPTV services are a technological advancement. Suitable modification has to be made in this policy guideline to enable IPTV service providers to get signals from broadcasters for provision of IPTV service. Telecom operators permitted under their license to provide triple play service or IPTV services can get signals from broadcasters only when provision of clause 5.6 of downlinking guidelines is suitably modified.

3.3.3 Ministry of Information and Broadcasting may take necessary action in this regard so that IPTV service providers can get TV channel feeds to provide IPTV service. Once this is done, then IPTV service providers would be entitled to receive content from broadcasters on “non-discriminatory” basis.

3.3.4 **Recommendations,**

The authority recommends,

The uplinking/downlinking guidelines should be amended to enable the broadcasters to provide signals to all distributors of TV channels such as cable operators, multi-system operators, DTH operators, HITS operators, IPTV service providers.

3.4 **FDI Cap**

3.4.1 Concerns have been raised regarding non level playing field if telecom service providers where FDI/equity Cap is 74% are

permitted to provide IPTV service while FDI cap for cable operators is 49%. Cable operators feel that provision of IPTV service will require huge financial resources and they may have difficulty in mobilizing financial resources. Such discrimination in maximum permissible FDI/ Equity Cap (74% in case of telecom and 49% maximum in case of cable operators) will be disadvantageous to cable operators.

3.4.2 Telecom service providers permitted to provide IPTV have also raised concern of non level playing field. They feel that they have to share their revenue {percentage of Adjusted Gross Revenue (AGR)} with government while cable operators are not subjected to any such revenue share. Moreover they also feel that they pay high license fee in comparison to cable operators which is just Rs.500/-. The Authority considered the concerns raised and is of the opinion that justice will be met if they are permitted to operate within the ambit of their respective licenses/registration. Each will decide on the basis of their business model once the rules of the game are clear.

3.4.3 Concerns were also raised that the media sector is a very sensitive sector and therefore even the Parliamentary Standing Committee on Information & Technology had rejected the proposal to increase the FDI in Media Sector. If telecom operators having 74% FDI cap provide IPTV, it will violate the FDI regulations prescribed by the Parliament. In this regard it is worth clarifying that IPTV services have two important constituents – content and carriage. The telecom service providers are permitted to provide carriage to provide TV and related services through IP platform; however they will take contents from broadcasters and other approved content providers which are regulated under Cable Television Networks (Regulation) Act 1995 and down linking guidelines.

3.4.4 Some of the stakeholders also raised concern about the existing cap on FDI for the production and telecast of news content, which is pegged at 26%. They also mentioned that there is a distinct possibility of IPTV service providers to create news content / produce the content by setting up their newsroom and upload the same on their servers. This would result in creating a disadvantageous position to the existing news channels vis-à-vis IPTV service provider with regard to FDI. As discussed earlier it would be appropriate that telecom service providers providing IPTV service do not produce any news content and show only those news channels which have permission from I & B Ministry.

3.5 Other Issues:

3.5.1 Some of the stakeholders also raised concerns about applicability of existing interconnection regulation and tariff orders for broadcasting sector to IPTV and also expressed a need to define QoS parameters for IPTV service. Here it is important to mention that “The Telecommunication (Broadcasting and cable Services) Interconnection regulations 2004 (13/2004)” issued by TRAI on 10.12. 2004 as amended from time to time define distributor of TV channels and does not specify any technology or Platform. Therefore it will be applicable to IPTV also.

3.5.2 The pricing, quality of service and tariff issues need to be handled separately under the respective licensing regimes.

3.5.3 The above clarifications will settle the doubts regarding provision of IPTV. This will facilitate launch of IPTV services and encourage competition, which will ultimately benefit the consumers.

Chapter 4

Summary of Recommendations

4.1 Licensing Issues:

The Authority recommends,

- (i) Telecom service providers (UASL, CMTS) having license to provide triple play services and ISPs with net worth more than Rs.100 Crores and having permission from the licensor to provide IPTV can provide IPTV service under their licenses without requiring any further registration. Similarly cable TV operators registered under Cable Television Network (Regulation) Act 1995 can provide IPTV service without requiring any further license.**
- (ii) Any breach of the provisions of Act/ License/ Registration/ Permission by telecom service provider/ cable operator/ Broadcasters shall be dealt with by designated agencies which are responsible for administering such Acts/ License/ Registration/ Permissions.**
- (iii) BIS may also be requested to look into it and expedite standardization of IPTV Set Top Box specifications to help cable operators while designing their IPTV networks.**

4.2 Content Regulation:

The Authority recommends,

- (i) The Telecom licensees while providing TV channels through IPTV shall transmit only such channels in exactly same form (unaltered) for which broadcasters have received up-linking/down-linking permission from Government of India (Ministry of Information and**

Broadcasting). In such cases, the responsibility to ensure that content is in accordance with the extant laws, rules, regulations etc shall be that of the broadcaster and telecom licensee will not be held responsible.

- (ii) In case of contents other than TV Channels from broadcasters, the telecom licensee shall be responsible for observing program code and advertisement code and such program code and advertisement code shall be the same as provided in Cable Television Network (Regulation) Act 1995 and Rules there under.**
- (iii) I&B Ministry and IT ministry are monitoring the contents relating to their jurisdiction. It would therefore be appropriate that respective ministries regulate the content provided by IPTV service providers. Operational procedures like time to keep a copy of the contents shown on IPTV, monitoring requirements etc can be worked out by DOT based on the feedback from respective ministries. Any violation of prevailing Acts/ Rules/ guidelines relating to content by telecom service providers in provisioning of IPTV service shall be reported to DoT by respective ministries. The decision of the respective ministries regarding violation of the law/ direction/ guidelines in respect to content shall be final. DoT may perhaps seek the guidance of the respective ministries to ascertain the penalties for the breach to maintain uniformity and shall initiate suitable action for imposing penalties for violations in time bound manner.**
- (iv) Telecom service provider providing IPTV will show only those news channels which have been approved by I & B Ministry.**

- (v) Suitable modifications may be made in respective licenses of Telecom service providers to incorporate above provisions.**

4.3 Down linking Policy:

The Authority recommends,

The up linking / down linking guidelines should be amended to enable the broadcasters to provide signals to all distributors of TV channels such as cable operators, multi-system operators, DTH operators, HITS operators, IPTV service providers.

International Experience

1. IPTV in Korea:

The Korean Broadcasting Commission administers the regulations related to the broadcasting industry, and the Ministry of Information and Communication is involved in the regulations of telecommunication industry. In order to operate a terrestrial broadcasting business or satellite broadcasting business, one needs to obtain a license from the Ministry of Information and Communication for a broadcasting station, as prescribed by the Radio Waves Act (Article 9, Broadcasting Act), upon receiving a recommendation from the Korean Broadcasting Commission. The same procedure is required to operate a cable broadcasting business.

The Korean Broadcasting Commission and the Minister of Information and Communication have discordant opinions regarding that convergence services should be regulated as broadcasting or as telecommunication. The Korean Broadcasting Commission claims to introduce a concept of “special category broadcasting service” into Broadcasting Act and to regulate a convergence service provider as a broadcasting company. The Commission insists that the convergence services should become a concept of “broadcasting,” based on the “opening telecommunication market” and “competition of the IPTV and cable television.” Since Korea allowed the foreigner to investment in the telecommunication service except broadcasting and basic telecommunication service through the WTO, if the IPTV is included in the concept of “value added network service,” the Korea government cannot help but accept the demand for the opening markets from foreign countries. The Korean Broadcasting Commission points out that if a telecommunication company enters into the broadcasting market that offers the IPTV services, there will be a possibility of causing collapse of the cable TV industry.

The Ministry of Information and Communication, on the other hand, claims to enact a new law, called Broadcasting and Telecommunication Convergence Service Business Law, and the Ministry insists on regulating a convergent service provider as a network business company. The Ministry of Information and Communication claims that the IPTV should be served as

value added network service for the following two reasons: the technical maturity which carries out the IPTV service is prepared, and that the delay of convergent service offer causes the result in declining of national competition in the international telecommunication market. While the Korean Broadcasting Commission insists that the establishment of a regulatory Institution and a regulatory framework should be considered first and that services should be launched later, the Ministry of Information and Communication asserts that the IPTV service should begin first and regulations should be reformed second.

2. Japan

The Ministry of Internal Affairs and Communications is a national system covering administration and regulation on broadcasting and telecommunication in Japan. Because of such an integrated system, the Ministry of Internal Affairs and Communications was able to respond to the convergent environment quickly. The advent of the separation of carriage and content in Japan stemmed from the enforcement of the Telecommunications Business Law in 1985 and the amendment of the Broadcasting Law and Radio Law in 1989. The enforcement of the Telecommunications Business Law caused the privatization of the Nippon Telegraph & Telephone Public Corporation and introduced competitions into the telecommunication industry. In satellite broadcasting, the amendment of the Broadcasting law and Radio Law brought a classification of the “facility-supplying broadcaster,” which has the equipment for broadcasting, and the “program-supplying broadcaster,” which provides contents. Accordingly, the separation of carriage and content was realized for the first time in Japan (Uehara, 2004). Moreover, the separation of carriage and content in the cable broadcasting was realized by the enforcement of the Laws Concerning Broadcast on Telecommunications Services. This law allowed the broadcasting service to provide the service by using telecommunication line facility in 2002.

The Laws concerning Broadcast on Telecommunications Service defines “Broadcast on Telecommunications Service” as “transmission of telecommunications intended to be directly received by the public, all or part of which is transmitted on telecommunications service provided by a person who operates telecommunications business” (Article2 of Chapter1). The IPTV is embraced in the concept of “Cable Broadcast on Telecommunications Services.” “Cable Broadcast on Telecommunications Service” means “transmission of telecommunications intended to be directly received by the

public, all or part of which is transmitted on cable telecommunications service provided by a person who operates telecommunications business” (Article 2-2 of chapter 1, Regulations for Enforcement of the Laws concerning Broadcast on Telecommunications Service). Those who did not have an installed facility and an obtained permission could not enter the cable broadcasting industry until then, because cable television broadcaster had regulated the Cable Television Broadcast Law. However, the enforcement of the law allowed content providers to enter the broadcasting industry by borrowing the telecommunication line facility from a telecommunication company.

Although there was such a reform of regulation as the one above, there are a few problems in Japanese IPTV services. Especially, it is pointed out that the different concepts on “broadcasting” become a cause to prevent the IPTV from expanding and activating. The definitions of “broadcasting” in the Laws Concerning Broadcast on Telecommunications Service and that of the Copyright Law are different. Although the IPTV is “broadcasting” in the Laws Concerning Broadcast on Telecommunications Service, it is included in “interactive transmission” in the Copyright Law. “Broadcasting” in the Copyright Law is defined as “the public transmission of radio communication intended for simultaneous reception by the public of the transmission having the same contents,” and “interactive transmission” as “public transmission made automatically in response to a request from the public, excluding the public transmission falling within the term ‘broadcasting’ or ‘wire-diffusion’”.

3 China:

In order to obtain a license to operate, an IPTV provider must have permission from several different state agencies, first and foremost a permit from the State Administration for Radio, Film and Television (SARFT) but also from the Ministry for Information Industry (MII), as IPTV is not only broadcasting but also a Value Added Service (VAS), which is in the competence area of MII. Furthermore, permits – depending on the types of IPTV service offered – have to be obtained from the Ministry of Communications (MOC) with respect to online games and from the General Administration of Press and Publication (GAPP), which is responsible for the censorship of audio-visual products⁴⁰. IPTV is thus under heavy regulation in China with respect to licenses for operation as well as content regulation.

In the 1999 #75 decree, a division of labour was implemented between SARFT and MII. SARFT has the responsibility for broadcast, radio/TV and cable television, while MII is responsible for telephony and Internet⁴¹. The problem with IPTV is that it falls between the two areas or covers both. However, SARFT has acquired the principal influence. IPTV took off slowly in China already from the very beginning of the century, but in 2004 SARFT established itself as the main state agency in the field with a licensing initiative for IPTV. And, SARFT licenses will only be issued to corporations in the broadcast and media area. These are the only companies eligible for licenses – meaning that telecom operators will have to work in cooperation with broadcast/media corporations to be able to operate in the area.

The implication is that the discussions and battles around the development of IPTV not only takes place between two different state agencies but also between state owned broadcast companies and state owned telecom companies. Furthermore, there is also a local-central dimension in the sense that local authorities do not necessarily accept licenses given by central state agencies. All in all, the situation in China with respect to IPTV regulation is characterised by some degree of regulatory uncertainty including inter-agency rivalry.

An important aspect of this is that SARFT is committed to promoting digital TV (not IPTV) in China. This means that their enthusiasm for IPTV is relatively small, as they are worried that IPTV may contribute to undermining the prospects for digital TV. This position is in line with their main area of work with an emphasis on traditional film, radio and TV. Furthermore, traditional media have a number of advantages for the authorities with respect to controlling content. The Internet is an open media and IPTV via the Internet will limit the possibilities for controlling and censoring content. With respect to content, there is another issue, which in many other countries plays a large role in relation to the regulation of IPTV, namely the protection of copyright. However, in China the tradition for upholding copyright is not very strong. This is illustrated in the fact that amongst the three barriers to the development of IPTV mentioned in the beginning of this section, piracy of content is the last one and the least important. However, copyright issues and the protection of copyright by way of technical protection measures such as DRMS (Digital Rights Management Systems) will eventually become an issue in the Chinese IPTV development.

Gist of Stakeholders' comments

1. VOICE

IPTV penetration is ESSENTIAL for the reasons of increase in Broadband subscriber. This also needs to be broad based i.e. ISPs also be included in the category to provide this service.

2. CONSUMERS' PROTECTION ASSOCIATION, TRIPURA

All the IPTV service providers (Both telecom service providers having license to provide triple play services under the Indian Telegraph Act 1885 and Cable TV Operators registered under Cable Television Network (Regulation) Act 1995) should be required to take a separate license from a designated Authority under the proposed amended Telegraph Act or the Rules as this will ensure uniformity in policy and enforcement.

3. BHARAT JYOTI CONSUMER ADVOCACY GROUP

i) No further License required for providing IPTV:

The UASL License issued by DOT permit THE Telecom. Service Providers to carry Voice, Data and other Telegraph signals over their wireline/wireless network. The Television signals are carried over transmission loop as Data Signals. The IPTV service is simply the delivery of digital TV signals to customers using Internet Protocol. The UASL Licensee is fully empowered to provide IPTV service to its customers. IPTV is a popular Value Added Service in many countries including Japan, France, Germany, Hongkong etc. The IPTV being an Interactive Service has got the added advantage of viewing Video on Demand, Time Shifted TV and equipped with many other features, not available in existing Cable TV (Analog TV Transmission) and DTH Services (Digital TV Transmission).

ii) IPTV and Cable TV are two different services:

There is hardly any commonality between the Cable TV and IPTV services, except the TV signal, whose transmission is totally different in the two services. It is improper to draw any parallel between the two services, which are different altogether. The Cable TV service may continue to be governed by Cable TV Network (Regulation) Act, 1995. The IPTV is a Value Added Service under the UASL License for operating Telecom services. The IPTV operated by UASL LICENCEES will be governed by their License conditions and regulated under Indian Telegraph Act 1885. As a matter of fact, the existing cable TV

operators should also be persuaded /forced to take a License for Cable TV, as TV is a Telecom Signal. Its transmission/delivery over a cable should require a License under Indian Telegraph act of 1885. Presently, there is no standardization and monitoring of Cable TV Transmission, which needs to be implemented to protect the customers from any harassment and poor quality of picture transmission. Any cable TV operator, if so desires could be allowed to provide Cable TV services using IP without requiring any License, as at present, unless License becomes a must.

iii) Regulation of Video content for IPTV:

As regards to regulation of the Video Content (other than broadcast TV Channels) for IPTV , a suitable provision has be made in the Telecom. License of the Service Provider, so as to make him responsible to observe programme code and advertisement code as provided in Cable TV act. It will be the responsibility of the broadcaster to take uplinking/downlinking permission from Govt. of India (Ministry of Information and Broadcasting) before providing Video channels either to MSO/ Cable TV or IPTV service provider.

iv) FDI/Equity Cap: The FDI/EQUITY CAP could be raised for Cable TV and made equal to 74 % as available to Telecom Service Providers.

v) Modification of Downlinking Policy:

A suitable modification may have to be made in the Downlinking policy so that IPTV Operator also becomes eligible to receive satellite TV Channel feeds from Broadcasters.

4. AUSPI

- As Unified Access Service License has provision for triple play service, all the Unified Access Service Licensees can provide IPTV service as per the license issued to them under the provisions of Indian Telegraph Act, 1885. Accordingly, the down linking guidelines clause 5.6 as proposed in the position paper needs to be modified to facilitate broadcasters/ content providers for providing content to the unified access service licensees for provisioning of this service.
- IPTV is a delivery platform and not a “service. Cable TV networks are not designed to communicate to individual subscribers. In terms of the definition of the “Cable Network” u/s 2(C) of the Cable Act; a cable network is designed to provide cable service for reception by multiple subscribers. In view of this, the Cable Operators cannot provide IPTV. Even if Government decides to amend the Cable Act, this shall have serious level playing issues like license fee, entry fee, jurisdiction etc.

- Cable operators are not required to pay any License fee which in turn is @ **6% to 10% of** revenues of UASLs. If IPTV is permitted to be provided by Cable Operators also, then it will be huge loss to Government exchequer.
- The telecom services are highly regulated in terms of security rules & regulations; hence UASL is the only most trusted and best monitored entity under the prevalent laws.
- The registration of Cable Operator is done only by a deposit of Rs.500/- in the nearest Post office and the number of Cable Operators is in thousands. If IPTV is permitted to be provided by Cable Operators, regulating and monitoring may not be practically feasible.
- Pricing and tariff issues need to be addressed urgently in order that IPTV service provided by Unified Access Service Licenses makes the service affordable to the consumers as well as increase competition in the market.

5. ISPAI

- Internet Service Providers (ISPs) are key stakeholders in the provision of IP services in India. Unlike almost all players in the telecom sector, members of ISPAI have the most extensive and rich experience in setting up and managing and providing services on IP networks. Several ISPs manage gigabits of bandwidth in their provision of services to their clients.
- In stark contrast to DoT's guidelines that specify that ISPs can provide IPTV, TRAI's position paper treats cable operators and telecom access providers as the sole providers of IPTV services.
- Neither cable operators nor telecom access providers have expertise or experience that make them automatic or unique candidates for provision of IPTV services which would require them to source new resources and enter into new partnerships.
- It is poor economic regulation to limit the number or type of players or technologies in a nascent and emerging market like IPTV where no player can claim exclusive rights to provide services.
- The fees paid for entry into telephony services by telecom operators cannot be a factor in limiting entry or competition in markets like IPTV which have little in common with any kind of telephony.

- Cable operators and ISPs – both of whom paid no fees for their non-exclusive licenses - cannot be treated unequally when dealing with entry into new markets like IPTV. Instead TRAI should take the lead in incentivising ISPs to provide all manner of IP based services. This will allow ISP's to make a business case and redouble there efforts to spread their services.
- IPTV markets must be open to all players who wish to enter the market.
- IPTV presents no new issues regarding security, privacy etc that warrant a treatment different from that given to existing content providers
- ISPs claims to provide IPTV and other services (e.g. internet telephony) are further reinforced by the fact that they are established license-holders in the telecom sector and have from their very inception complied with existing guidelines, rules and submitted themselves for scrutiny of government agencies.
- TRAI must focus its efforts on enabling ISPs to provide a full range of services to Indian consumers and to compete fairly in the market. TRAI must especially act to remove the unfair advantages enjoyed by telecom operators who are able to bundle access services with their internet offering and thereby hurt pure play ISPs in the market place.
- TRAI must heavily regulate the Service providers with Significant Market Presence to ensure that cartelization; monopolizing and unfair trade practices by them are monitored and controlled. On the other hand TRAI should offer a light handed approach to smaller players with incentives so that they can grow and spread their services in interest of consumers, meeting of penetration targets and competition

6. CASBAA

As a matter of principle, CASBAA supports even-handed regulation of pay-TV platforms, no matter the technological base on which they repose. When pay-TV systems deliver linear video streams to consumers they should be regulated in a similar fashion. This support is grounded in the belief that the underlying technical aspects are irrelevant to consumers, who are interested in the content they receive and the price they pay. Setting a level regulatory playing field that permits operators to earn a market-determined rate of return, and maintaining as few obstacles to market entry as possible will facilitate entry of new operators, produce an increase in choice available to consumers, and ensure the price they pay is subject to market

discipline. Experience elsewhere in the world has demonstrated that open markets and evenhanded regulation produce the greatest benefits.

Governments everywhere are struggling to adapt existing legal and administrative structures to cope with the reality of technological and commercial convergence, in which telecom services and television programming are conveyed to consumers by a variety of channels, each of which is capable of delivering the entire range of broadband services. Where – as in most countries – convergence legislation is not yet in place, CASBAA advocates that existing legislation be applied in a manner that creates as level a playing field as possible.

The Indian regulatory framework already incorporates differential approaches to pay-TV transmission systems with respect to a number of regulatory issues, as DTH systems are regulated differently from cable companies, including on issues such as foreign investment, pricing, and quality-of-service. The TRAI now proposes to increase the complexity of the system and worsen the differential treatment of transmission means, by creating yet another alternative regulatory framework, this one for IPTV, which would have still different rules. In our view, this is the wrong direction, and we would urge TRAI (and the other relevant government offices) to seek to increase the consistency and levelness of pay-TV regulatory policies as between different transmission media.

TRAI's extensive argumentation to the effect that IPTV is different from cable TV does not stand up in the light of experience elsewhere in the world, where existing IPTV systems operated by telecom companies are providing bouquets of linear program streams to consumers under virtually identical conditions to those prevailing for traditional "cable" companies. An argument for differential regulation based on the fact that digital signals enter the home in a different way for IPTV than for cable is not a practical basis for regulation, when the market realities, as they confront content generators, potential platform operators, and consumers, treat the signals identically. They are completely competitive with one another, when used to deliver linear program streams.

CASBAA therefore advocates that the goal of regulatory policy must be to treat "linear" IPTV in a level-handed manner as compared to with existing pay-TV modes of delivery – cable and satellite-based DTH systems. If the existing legislative framework does not support this treatment, the regulatory authorities should seek new legislation to firmly enshrine even-handed legislation. Recognizing that such legislation takes time to develop, as a temporary expedient, many countries have adopted measures that apply even-handed policies to IPTV through parallel legislative/administrative means. This protects the principle of "technology neutrality" of regulatory policy.

7. Motion Picture Association

Principles of regulatory framework

- MPA supports the primary thrust of the IPTV Consultation in providing clarity on who can provide IPTV and under which legislation.
- Market forces best promote competition and consumer interests. IPTV should not be regulated or regulation should be light-handed, particularly given that it is a nascent technology and television markets are subject to competition.
- A convergent, technology-neutral approach is required. IPTV and competing Cable TV should be regulated on the same basis. Rather than regulating IPTV, this means Cable TV should be deregulated.
- IPTV and Cable TV regimes, if separated, must still provide a level competitive playing field to ensure that competition is on the merits. Again, both regimes should be subject to light-handed regulation.

Content regulation and promotion

- Control of content on IPTV should be based on self regulation, as should be the case for Cable TV.
- Any content regulation should balance public protection against demand.
- Technical standards should include content protection measures, particularly for IPTV where the high risk of content theft can so easily be reduced by content protection implemented at the set-top box.
- The IPTV Consultation recommendation to remove legislative obstacles to content provision is an essential output of TRAI's work. Cable legislation requires amendment so that broadcasters can supply content to IPTV operators.

8. Mr. Vijay Mansukhani

- Cabled TV carriers frequency domain is 5-862 MHz while Telco's copper frequency domain is below 5 MHz.
- TV broadcast channel spectrum bandwidth is 7 or 8 MHz against Telco services spectrum width of 4 kHz., which can transport video only when packetized into 4 kHz spectrum domain as data.

- Thus Broadcast TV video delivered in 4 kHz spectrum width and viewed on computer screens would fall in TELCO domain but when viewed on domestic TV receiver would rightfully fall in Broadcast domain.
- Cable TV industry should not grudge delivery of video over computer screens by TELCOs.
- Broadcast TV content, satellite casted or terrestrial, transported over wireline for viewing on TV receivers should be treated as Cabled Broadcast.
- Time shifted TV, video games etc are functions more conducive to a hard disc in the set top box. With server based archiving, mandatory in DTH, even Cable TV networks can lift them from repositories and deliver to viewers. Hence these are not peculiar to IPTV as being projected as a superiority feature in the position paper.
- **Provisions of Section 4A of Cable TV Act come in to play, if Telcos transport Broadcast TV content on wire line and deliver video on TV but will not be applicable for the same video display on PC.**
- **Similarly Section 9 of Cable TV act will not be contravened for delivery of video on PC by Telcos**
- Network set up by UASL holding TELCO is designed to provide telco services i.e. voice and data in general and video (NOT broadcast television) in addition.
- Telecom loop would carry video (as distinct from Broadcast TV content) in packets form. i.e. data as unicast. But if TELCOs instead of DSLAMs install an access gateway at the user proximity edge, with storage, for multi-casting on viewer's domestic TV receivers, then the service would be deemed Cabled Broadcast to fall under Cable TV networks regulation statutes.
- TELCOs aggregating Broadcast content at their Central Office (Headend in Cable TV parlance) and claiming its transport as point to point communication in TELCO parlance, to keep out of Cable TV regulations, does not hold ground, since thousands of subscribers will be accessing real time Broadcast relayed from their Central Office to wire line connected customers wherein content would flow from one to many recipients at the same time on domestic Television receivers.

- Therefore, real time Broadcast Television content delivery, over wire line networks by TELCOs, for viewing on Television receivers, should be treated as Cable TV while time deferred TV content, or server based video content for viewing on computer screens could remain in TELCO service domain.

9. Airtel

A logical corollary of this conclusion would be that the grey areas identified in respect of the Act have no implications for IPTV service offered by Telecom Service Providers viz. necessity to use STB to offer FTA channels, non-availability of BIS approved STB for IP TV service, FDI ceiling of 49%.

“Technology Neutrality” between IPTV Service and Cable TV Service is totally misplaced and untenable since IPTV is not a technological development over copper cable TV network but a clearly differentiable service being non-linear and offering tremendous value by enabling real interactivity and on-demand service which are inconceivable in Cable TV service such as Time Shift TV, Video-On-Demand, Pay-Per-View etc.

10. Hathway Cable & Datacom

1. Hathway has no issue in as much as the Telecom Operators increase revenue by providing value added broadcast TV services through Internet protocol [“iPTV”] as long as consequential level playing field is provided in the cable services.
2. Level playing field is explained herein. Admittedly iPTV will provide its broadcast / television content through addressable mechanism on pan India basis in one go. Whereas conventional service providers over last 15 years be its cable operators and MSOs has not been given due consideration of providing its services in addressable mode despite report of the expert group recommending in providing addressable services in 55 cities over a period of next 1–3 years time frame.
3. Experience in CAS notified areas of Delhi and Mumbai, where Hathway is operating shows that subscribers on an average are subscribing for not more than 12 pay channels. Such messages have been spread in places and the Subscribers from other non-CAS area are demanding that when they are not watching for more than 12 pay channels on an average then why should they pay for over 80 pay channels currently being delivered by default in un-addressable system.

4. Without creating level playing field amongst the service providers, the Position Paper on IPTV currently under consideration is *ex-facie* apparent that one set of service providers are being given favourable treatment over other.
5. Systematic favorable positioning to one sets of service provider would create wrack in the business and revenue model of current cable / content delivery systems, which admittedly providing huge employment and entrepreneur opportunities to lakhs of people associated directly or otherwise in the trade and business of cable TV.

11. HBE India

1. IP TV service is permitted to Telecom Service Providers under their Unified Access Service License as amended by the Department of Telecommunications (DoT) vide Circular No. 10-21/2005-BS.I (Vol.II)/54 dated December 14, 2005 whereby DoT incorporated the following provision in the UAS/CMTS Licenses:
Clause 2.2 (a) (iii):
The access service providers can provide Broadband services including triple play i.e. voice, video and data.
2. We completely agree with TRAI's position that IP TV Service offered through a Telecom Operator's Network, using wireline (copper/optical fibre) and wireless media cannot be termed as "Cable Service" and therefore, the Cable Television Networks (Regulation) Act 1995 (hereinafter called "the Act" cannot apply. Therefore provisions of Cable Act do not apply to Telecom Operators such as necessity to use STB to offer FTA channels, use of BIS approved STB only for IP TV service, FDI cap of 49%.
3. We support immediate amendment to the **Downlinking Policy** dated November 11, 2005 issued by the Ministry of I&B to permit Broadcasters to provide TV Channels to IPTV Service Providers in addition to MSOs, Cable Operators or DTH Operators.
4. We agree with the stand adopted by TRAI that IP TV content shall be regulated by Ministry of I&B, while transport network of Telecom Operator shall be regulated by DoT and transport network of Cable Operator shall continue to be governed by Ministry of I&B.

12. IMImobile

Consumers are agnostic to technology behind the TV screens. It could be a traditional cable/CAS/DTH/IPTV service. In the end it means a transmission service on TV with better interactivity and more choice. So the arguments backing how IPTV service is technologically different

from a traditional cable/DTH service does not hold good. From a customer point of view it is the same service.

Technology is converging faster than our legislations. It is time for a converged legislation that creates a level playing field for different capable market players. The different acts – telegraph and cable TV network act are ‘archaic’ in this sense and should be given a relook by the Ministry and regulator alike. The debate on what UASL covers and what cable license covers is losing its relevance in this converged era. The converged legislation should reconsider the following, primarily.

- 1) Definition of different emerging services – Mobile TV, IPTV etc as the underlying technologies converge the broadcasting and telecommunication spaces.
- 2) Level playing field in terms of FDI caps and regulations.

The service at the end, in the customer’s living room, will be a service on TV. The extant content code, program code and advertisement code should continue to apply. Though these codes are covered under cable act only the service continues to be a service on TV and service providers should observe the rules.

The modifications in both telecom and cable acts should be brought under a single converged legislation in order to provide a level playing field for cable operators and telecom service providers.

Administering the same service provided by two different sets of players by two different regulators is a cumbersome task. The service should be brought under single legislation and be administered by single agency for effective moderation.

13. IndusInd Media

By this principle what is being urged is that while incumbent players are fully willing to cope with competition from emerging technologies and indeed the market place, all existing and new regulation in this sector must ensure that laws/regulations and executive directions of the Regulator/Government create an environment of level playing field ensuring healthy and even competition. With this caveat, we give our views on the position paper on IPTV.

The position paper appears to have missed out certain fundamental principles of delivery of data, audio and video. The Regulations pertaining to Indian Telegraph Act, 1885 has been amended from time to time keeping in view the technological advancements yet fundamentally they allow carriage of analogue frequencies in digitized or analogue format. Similarly the video content can be carried in analog or digital format.

The Cable TV Regulations made in 1995 were in keeping in view the technology available at that time for delivery of video. At that time IPTV (which is commonly used for delivering TV signals through internet protocol) was not envisaged.

The Authority is well aware of the concerns of the cable industry that while the Cable Act of 1995, broadcasters using cable transmission or DTH players using broadcast signals are not directly covered by Parliamentary enactments. Based on the principle of level playing field, the cable industry has been demanding equitable regulation for **all forms of video delivery** currently in vogue or which will come in vogue so that the widest possible choice is made available to customers but without any bias against incumbent players.

- The main concerns of the Authority on provisioning of IPTV services are related to the fact that Cable TV Act 1995 had not envisioned IPTV leading to:
- Use of STB may lead to non-compliance of Cable TV Act allowing FTA channels to be made available without an addressable system.
- Use of different devices may violate requirements of cable act in reference to adherence to prescribed standards.
- FDI norms/Downlinking guidelines and programme codes would need to be prescribed for IPTV.
- COMMENTS: Our considered stand is that all these concerns can be taken care off by appropriate amendments or issuance of executive guidelines. In addition:
- All Broadcast TV content, satellitecasted or terrestrially telecast, transported over wire line for viewing on TV receivers should be treated as video Broadcast and be subject to the same regulation in so far as customer service is concerned.
- Cable TV networks in India, at present, are largely uni-directional but elsewhere are bi-directional. Thus as long as the criteria laid down in the extant ISP regulations of August 24 are concerned, are capable of providing IPTV. Hence there is no need to carve out an exception for telecom IPTV players. For voice delivery on Cable TV networks, existing regulations have to be amended since networks have technical capability. On such networks VOD, games, e-Governance, tele shopping, tele banking, distance education etc can be provided.

- Interactive wire line Broadcast networks supported by Servers and dynamic bandwidth control can deliver much better QoS with Subscriber Management Services.
- Interactive Cable TV networks for delivery of interactive video and data services do not require IP technology. In advanced Cable TV networking, QAM-IP-QAM conversions can make service of multi channels delivery on TV possible from only one Headend in the country. Integration of voice would requiring enabling amendments in the regulations

The paper does not address this and seem to be finding ways of differentiating of IPTV and Cable TV in favour of Telecom players. Fundamentally IPTV is only one more way of carrying TV/Video signals must be kept in mind and hence all regulations as applicable to content carriage should and must be applied on the principle of level playing field.

14. Intel

1. As stated in Paras 1.2.2 to 1.2.5, in general, we agree with the stated objective of removing impediments in a timely manner, at the same time maintaining technology neutrality while fostering innovation and investment, impartially across all market participants.
2. Putting in place an unambiguous and simple regulatory framework for advanced video services (including, but not limited to, IPTV technologies) would help launch deployments of advanced network technologies on a mass scale by various operators.
3. Para 3.2.i-3.2.ii – While the legal implications have to be considered, an interface device (such as a set-top box (STB)) may be viewed as a technical requirement for receiving advance video services. Television sets generally only have an (integrated) interface device that is compatible with legacy television signal formats. Section 4A of the Cable Act requires a specific receiver interface technology, for the purpose of consumer access to Free-to-Air channels. Intel believes the intent of the requirement can be met for advanced video services, with a conversion device in a STB. It seems unlikely Section 4A intended to serve as a *defacto* barrier to future technology advances and signal format improvements, and more likely intended to maintain compatibility with the large installed base of televisions. A STB with conversion device meets the spirit of that requirement.

4. Para 3.11 to 3.15 - While there are architectural and user-interface differences between Cable TV networks and DSL-based IPTV networks, the content (TV channels) would be available to the subscribers as required. The subscribers can choose among the channels, and the internal network technology differences are transparent to the subscribers. Adopting a technology neutral approach and letting the operator choose the technology appropriate for their business model allows both the telecom operator and cable operator to deploy any advanced video technology, IPTV or other.
5. Para 3.16 – As explained above and rightly highlighted by TRAI – the ‘Cable Television Network (regulation) Act 1995” does not regulate the technology that has to be used by the cable TV operator, which emphasizes the technology neutral approach. Hence, the differences in technology between an IPTV network and a cable network should not form the basis for policy conclusions.
6. Besides IPTV, there are other choices of technology for delivering advanced video services, and likely more in the future. For example, Verizon in the US is not deploying IPTV for television service, but has instead invested billions of dollars in deploying an advanced-technology fiber network that operates very similarly to a cable network. This network is more future-proof in bandwidth capabilities than a DSL network retrofitted to provide IPTV, but it can also integrate IPTV technologies in the future. An Indian provider wishing to make a similar investment would therefore not benefit from any impediments removed by the proposed changes, simply because they are not deploying IPTV technology. Yet, such a deployment would surely be welcome under the policy goals of TRAI, considering the technology neutral approach and promoting investment and innovation.
7. In keeping with the technology neutral approach, Intel suggests that the policy should not favor or single out IPTV technology, but should benefit any new entrant or incumbent that advances the policy goals, regardless of technology. The approach outlined in the position paper makes technology-specific comparisons, and conclusions thereof. Taking a long term view, it seems appropriate to change the wording from IPTV to something more technology-neutral like Advanced Video services (delivered by any technology, IPTV or other). Indeed, there are innovative new technologies on the horizon, such as multiple wavelengths over optical fiber, which may not even utilize the IP layer. It would be unfortunate to have to revisit this issue again, simply because it focused too heavily on a particular technology, namely IPTV. It would also be unfortunate if an operator felt a disincentive to

invest in such new or future technologies because the regulatory language only gave clarity to IPTV technology.

8. Para 3.22 - The conclusion reached by TRAI is welcome and will provide an opportunity for both cable TV operators and telecom operators to deploy advanced network technologies. However, we suggest that a different approach be adopted to arrive at the conclusions. It would be beneficial to assess the historic policy reasons the requirements were first implemented in the Cable TV Act relative to the present. If the reasons for the requirements of the various sections of the cable act still apply, then in order to meet the goal of being competitively impartial and technologically neutral, all new providers of advanced video service (regardless of technology, IPTV or other) may comply.

15. Microsoft

The position paper on provisioning of IPTV services provides clarification on a number of ambiguous regulatory issues and recommended associated changes to existing policies such as the down-linking guidelines.

These, when implemented, will definitely help to boost market activities and investments in IPTV services, as well as the underlying broadband infrastructure. On top of these very positive stances, we would like to bring to attention of the Authority that both IPTV technologies and services (including contents) are in their infancy and are bound to evolve and expand continuously over time. As such, we recommend that the Authority take a broader and forward-looking view regarding IPTV definition, scope of contents and other related aspects like the devices and the standards, etc. so as to develop a regulatory framework that anticipates and evolves along with the IPTV technological and market developments.

Need for a broader definition of IPTV

Section 3.1 of the Position Paper defines IPTV as “**provision of television signal using Internet Protocol for transmission of signals to the subscribers**” (over various access technologies). While it is correct that IPTV implements “TV over IP”, this definition is both narrow and incomplete.

As per ITU-T’s **Working Document : IPTV Service Requirements**’ dated 31st July 2007 (<http://www.itu.int/md/T05-FG.ITV-DOC-0114/en>; please see page 6) “**IPTV is defined as multimedia services such as television/video/ audio/text/graphics/data delivered over IP-based networks managed to support the required level of**

QoS/QoE, security, interactivity and reliability". It is noteworthy that this definition has been approved by FG (Focus Group) IPTV plenary and is not subject to change or modification.

Hence, it would be useful for India to adopt the ITU definition for IPTV.

ITU definition clearly shows that transmitting TV programs over IP is just one of the basic features of an IPTV system while the full spectrum of IPTV services include many other types of contents plus interactivity.

Furthermore, when IPTV is defined as "multimedia services" over "IP-based networks", it inherently implies that its contents are beyond mere "TV channels" (see next section).

Need for a broader scope of IPTV content

Section 3.18 of the position paper states that "***IPTV provider can get channels only from broadcasters***".

While it is fundamentally necessary that broadcast channels are also made available over IPTV, we would like to point out that IPTV providers should be allowed to offer additional content beyond mere re-transmission of broadcast channels as well.

In the broadcast and cable service sphere, number of (analog) channels are limited by the RF spectrum constraints. However, with IPTV and digital technology, there is virtually no limit on the number of channels that the service providers can offer.

This is a key differentiator and benefit of IPTV. Given such unlimited number of channels, IPTV service providers should be allowed to acquire, aggregate, and package additional contents (which may include movies, archive TV programs, documentaries, special interests contents, e-learning courses, music & games, etc.) into "**virtual channels**" or Video On Demand (VoD) libraries for subscribers to access, alongside the broadcast TV channels. This is essentially the "long-tail marketplace" that IPTV technology and platform are enabling, and it is especially beneficial not only to end consumers, but also to the content creators & owners as well as the service providers, leading to evolution of a sustainable eco-system around IPTV and providing impetus to the broadband growth and overall economy in the country.

Experiences from many operators around the world who have launched commercial IPTV services have shown that it is essential for IPTV service providers to provide differentiated

contents over and beyond broadcast channels in order to attract subscribers. In many countries, regulators are recognizing such needs and the associated benefits to the overall economy, and are actively reviewing and revising both broadcast regulation and copyright laws in order to facilitate both the retransmission of broadcast contents over IP infrastructure and the ability for IPTV providers to independently acquire, aggregate/syndicate, and package additional contents.

In view of the foregoing, we urge the Authority to specify, recommend, support and endorse a broader scope for IPTV content, beyond broadcast channels - to include VOD & time-shifted TV, etc. It is noteworthy that there is an increasing trend in integrating communications capabilities (such as VoIP and text messaging) with the IPTV service offering.

As such, the IPTV content regulation should take into consideration such emerging as well as other future possibilities.

Additionally, we recommend that the up-linking and down-linking guidelines be revised accordingly to permit various content providers (including broadcasters) to provide their content and reach consumers through IPTV service providers. While broadcasters ensure that the existing broadcast channels comply with the extant program code and advertisement codes, IPTV service providers should be allowed to create and package additional contents/channels while taking onus that such contents / channels comply with the extant content code.

Devices:

While PCs and STBs are already mentioned in the Position Paper, it would be useful to have a broader and generic definition that includes other devices like embedded TVs and game consoles, etc. as well.

Standards & CODECs:

While the Position Paper does mention one of the standards, viz. 'RTSP' others like HTTP/TCP too exist and many more may come up. Similarly, the position Paper does mention MPEG-2 in the context of providing live TV, others like VC-1 too exist and many more may come up. Hence, it would be desirable that choice of standards & CODECs be available with the implementers and users.

16. MTNL

- As IPTV is an interactive service, it cannot be covered within the definition of present day Cable TV and DTH system rather this is a new category of service not covered under any of the present day service. So, the regulation should cover the future services which may be offered within the definition of an interactive service.
- It is understood that as IP TV services are value addition to the existing broadband services, the same may be provided under Basic/ Cellular Mobile service license as value added service. Necessary clarification may be issued by the licensor in this regard. Therefore, both telecom service providers having license to provide access services under Telegraph Act and Cable Television Network (Regulation) act 1995 can provide IP TV service without requiring any further license or registration.
- Content providers should be registered for providing contents to the IP TV service providers and they should be held responsible for observing program code and advertisement code. An IP TV service provider is responsible to take the content only from the registered content providers to ensure that the content is as per the program code and advertisement code as defined in The Cable TV Act, 1995.

17. NDS

Promoting a Level Playing Field

NDS welcomes any regulatory development that will facilitate the growth of new free-to-air and pay TV services, provided that the regulatory development will not significantly favour one type of service platform or delivery method over others.

Unfortunately, TRAI's Position Paper does not meet this "level playing field" criterion. It clearly and significantly favours Telecom Service Operators over Cable Operators in the provision of what is by any reasonable definition a service more akin to cable TV than to telecom services like voice or broadband.

Whether or not telecom-delivered IPTV and cable-delivered IPTV are regulated under separate or the same Acts/ Licenses/ Registrations/ Permissions, the top-level direction of regulations down to the details should be the same wherever this is feasible, or at least as closely aligned as possible.

Equal Opportunity Should Bring Equal Obligation

NDS believes that, with great potential business and opportunity for the Telecom Services Operators providing IPTV should come commensurate responsibilities and obligations. These should include responsibilities and obligations to protect the following, at least to the same level as the Cable Operators' responsibilities and obligations:

- a) the consumer
- b) the intellectual property rights integrity of the content that they acquire from content providers and broadcasters
- c) the content norms of India
- d) a level playing field across all linear content delivery platforms.

Converging Services Require Converging Regulation

The approach taken by TRAI in this Position Paper is to promote or maintain divergence or bifurcation of regulations rather than convergence. Apart from making the regulations more burdensome to apply and comply with, this inevitably will lead to many more "borderline" cases which will need arbitration and determination.

If continued, this is a recipe for confusion and stagnation in the long term, as TRAI and the industries involved will find it hard to keep up with new regulations for a multiplicity of future content delivery platforms.

Effective Regulation Must be Self-Consistent

Some of the TRAI positions presented in the Position Paper appear to be inconsistent and self-contradictory.

For example, Cable Operators will be able to offer IPTV, since registration under the Cable Television Network (Regulation) Act, 1995 "does not regulate the technology for providing such services" according to Section 3.16, but not as far as the STB, since that must conform with Section 9 of Cable Television Networks (Regulation) Act, 1995 about use of equipment conforming to Indian Standards according to Section 3.2 (ii).

If the clarification in Section 3.16 only permits Cable Operators to use IP protocols within their networks, but not to the home, then this Section with its apparent concession to Cable Operators is misleading and should be deleted.

Regulation should be Technology Neutral to Remain Self-Consistent in Future

The legalistic technical arguments TRAI uses to delineate Telecom Service Operators' linear IPTV from Cable Operators' linear IPTV in Sections 3.10 to 3.15 fail if one chooses alternative available technologies for either the Telecom Service Operator's platform or the Cable Operator's platform.

For example, fibre-to –the-home (FTTH) – with its very high capacity – can deliver the whole range of content on IPTV STB simultaneously, just as “classical” cable does to a cable STB. If an Indian Telecom Service Operator were to choose to roll out FTTH anywhere, then following the arguments presented in 3.10 to 3.13, one would conclude that the service should be a cable service. FTTH is extensively used in Japan.

On the other hand, switched digital video technology is used by cable operators to ensure that only content being watched in one or more cable homes in a node (typically 1,000-2,000 subscribers) is actually sent to those homes. This enables more efficient use of the cable network, particularly the last mile. Using the arguments presented in 3.10 to 3.13, one would be hard pressed to conclude whether a service using such technology should be a cable service or a telecom service. Switched digital video technology is used by several MSOs in the United States.

Consumer Device/Customer Premises Equipment

NDS acknowledges that there are differences in the delivery technologies which do necessitate different regulatory specifics – for examples as noted the inability of IPTV to deliver any free-to-air services without a set top box and the possible use of different protocols to deliver IPTV over telecom and cable networks.

However, it certainly is possible to apply consistent regulation to many aspects of consumer devices to be placed in TV viewers’ homes including but not limited to: product safety, compatibility with other consumer devices including TV sets, VCRs and audio systems where applicable, basic performance characteristics of RF, video and audio outputs, operating temperature and humidity ranges, electromagnetic compatibility, product marking, environmental survivability and performance and product lifetime.

Moreover, the fact that IPTV is technically unable to meet one or two technology- specific requirements of The Cable Network (Regulation) Act, 1995 as amended should not mean that all the other consumer related obligations in that Act should be swept aside.

Content Norms Related Obligations

If Telecom Service Operators are to enjoy such privileges as equal access to content for their linear IPTV services, then they should also take the same responsibilities as Cable Operators for ensuring content norms are maintained. NDS believes the content norms for linear television should be equally upheld regardless of the delivery platform.

It would appear that, under the proposed regulation, if a content provider providing the same channel to Cable, DTH and Telecom Service Operators’ IPTV platforms were to breach the programming codes, the content

provider and the Cable and DTH Operators would be held liable; whereas the Telecom Service Operator would not.

18. OPTIBASE LIMITED

1. IPTV service is permitted to Telecom Service Providers under their Unified Access Service License as amended by the Department of Telecommunications (DoT) vide Circular No. 10-21/2005-BS.I (Vol.II)/54 dated December 14, 2005 whereby DoT incorporated the following provision in the UAS/CMTS Licenses:

Clause 2.2 (a) (iii):

The access service providers can provide Broadband services including triple play i.e. voice, video and data.

2. We completely agree with TRAI's position that IP TV Service offered through a Telecom Operator's Network, using wireline (copper/optical fibre) and wireless media cannot be termed as "Cable Service" and therefore, the Cable Television Networks (Regulation) Act 1995 (hereinafter called "the Act" cannot apply. Therefore provisions of Cable Act do not apply to Telecom Operators such as necessity to use STB to offer FTA channels; use of BIS approved STB only for IP TV service, FDI cap of 49%.
3. We support immediate amendment to the Downlinking Policy dated November 11, 2005 issued by the Ministry of I&B to permit Broadcasters to provide TV Channels to IPTV Service Providers in addition to MSOs, Cable Operators or DTH Operators.
4. We agree with the stand adopted by TRAI that IP TV content shall be regulated by Ministry of I&B, while transport network of Telecom Operator shall be regulated by DoT and transport network of Cable Operator shall continue to be governed by Ministry of I&B.

19. ORTEL

While discussing the technology for IPTV, chapter 2 has only detailed ADSL technology, employed mainly by telecom operators for broadband services, and has not discussed technologies used by cable TV operators for such services. We would like to bring to Authority's notice that IPTV services will be increasingly offered, employing an Architecture based on Hybrid Fiber Communication (HFC) networks, using the state of the art Data Over Cable Service Interface (DOCSIS). DOCSIS is an ITU approved standard, which is developed to take advantage of HFC networks, for provision of 'Triple Play' services of which IPTV is an important part.

In the future, even broadband wireless access networks based on both

terrestrial and satellite technologies, will be employed to deliver converged multimedia services including IPTV. In the light of these developments the licensing regime for IPTV should be made technology and network platform independent.

In view of technological developments towards full convergence of telecom and cable TV services, the need of the hour is to provide for a convergent regulatory and licensing regime. In the long run a Convergence Act should replace both Indian Telegraph Act and the Cable Act, so as to finally remove all the 'regulatory grey areas' brought out in the position paper.

20. Reliance

IPTV can not be provided under Cable TV Networks Regulation Act, 1995 due to the following provisions of CTNA :

(i) Clause 4A : It is mandatory to provide programmes of the basic tier without any addressable system attached to the receiver set.

The Authority has specified ceiling charges for the cable services in CAS and Non-CAS areas. The CAS and Non-CAS areas are not applicable for IPTV and therefore these price ceilings are not applicable for IPTV. Similarly standard tariff to provide STBs on rental cannot be made applicable for IPTV as STBs for IPTV are different in terms of costs and applications.

TV signals are also provided by DTH operators but they are not covered under Cable Television Network (Regulation) Act, 1995. In fact DTH license is granted under the provisions of Indian Telegraph Act, 1885. Provision of IP TV has to be regulated under Indian Telegraph Act, 1885. Cable operators willing to provide IPTV service by using their cable network may take appropriate license under the Indian Telegraph Act, 1885 for provision of such services. This will also provide a level playing field to providers of such service and would be regulated by the same regulations/act.

Interconnection Issues

1 TRAI has not taken up the interconnection issue, which is most important and crucial issue for all addressable channel delivery systems. The broadcasters do not provide content on a-la-carte basis and insist that their complete bouquet of channels be included in the basic bouquet. This defeats the whole purpose of introducing addressability on delivery platform. All channels in the basic bouquet make the service unaffordable to larger section of the consumers and therefore services remain unattractive.

2 The addressable market can be expanded in case broadcasters agree to provide channels on a-la-carte basis. Otherwise addressable system like IPTV cannot give effective competition to the incumbent cable operators.

21. SIFY

Authority should review the conditions proposed in the position paper to include ISPs in its purview especially in the light of recent guidelines wherein ISPs having a net worth of Rs 100 crores or more have been allowed to provide IPTV.

22. Smart Digivision

Cable Operators are not subjected to any entry fees. UAS Licensees have also not been subjected to any additional entry fees/ barrier for IPTV services. Thus, it would be only fair that a level playing field is maintained.

Given that there have practically been no barriers to providing video content services, we believe that the low entry barrier stance should continue. ***Any prospective regulations on providing video services over broadband networks should not create preferential rights or entry barriers for anyone. Telecom Operators, Cable Operators and ISPs should be equally positioned to offer these services.***

Challenges to operating under Cable TV Act can be overcome & should be supported

In order to enable IPTV Services under the Cable TV Act, so as to provide equal opportunities to all kinds of operators, grey areas for providing IPTV services under the Cable TV Networks (Regulation) Act could be addressed by modifying the relevant clauses in the Act to accommodate the technological nature of the IPTV service.

Alternatively, the following workable solutions could be considered by the Operators: with support from TRAI and Government:

	GREY AREAS	SOLUTION
1	Technological requirement of IPTV to deliver content through a STB leads to non-compliance with the requirement of Section 4A of Cable Television Networks (Regulation) Act, 1995 about Free-To-Air channels not	For customers wanting to watch both Pay channels and FTA channels, STB would be required. For the smaller fraction of customers wanting to watch FTA channels only, operators could provide STBs free of charge & free of any deposit. Vanilla STBs (that

	needing an addressable system in CAS notified areas.	enable decoding of digital feed to analog) can be provided for such customers. Our assessment is that the regulated tariff of Rs 77 for FTA is sufficient to deliver the services economically with a free STB for such customers.
2	Use of different protocols by different companies and lack of standardization for IPTV services may violate the requirement of Section 9 of Cable Television Networks (Regulation) Act, 1995 about use of equipment conforming to Indian Standards.	This condition could be seen as potentially violated only when the standards are prescribed. At present, there are no prescribed standards for IPTV equipment. The standards could be prescribed in line with international practices.

23. TATA

If the Govt. allows Cable operators to offer IPTV, it should be ensured that the Cable operators should be made responsible to adhere to the security & other relevant licensing conditions (including payment of License fee @ 6%/8%/10% of AGR) as per applicable to UASLs, to maintain a level playing field.

24. Time Broadband

Points which the industry has been eagerly looking at TRAI as the sectoral Regulator with strategic flexibility and understanding of all-round revenue un-locking, is up-holding the Intellectual property-rights issue for royalty partner & share model; as we all wish the User-segment to pay less for more Content used.

25. UTStarcom

1. IPTV service is permitted to Telecom Service Providers under their Unified Access Service License as amended by the Department of Telecommunications (DoT) vide Circular No. 10-21/2005-BS.I (Vol.II)/54 dated December 14, 2005 whereby DoT incorporated the following provision in the UAS/CMTS Licenses:

Clause 2.2 (a) (iii):

The access service providers can provide Broadband services including triple play i.e. voice, video and data.

2. We completely agree with TRAI's position that IP TV Service offered through a Telecom Operator's Network, using wireline (copper/optical fibre) and wireless media cannot be termed as "Cable Service" and therefore, the Cable Television Networks (Regulation) Act 1995 (hereinafter called "the Act" cannot apply. Therefore provisions of Cable Act do not apply to Telecom Operators such as necessity to use STB to offer FTA channels; use of BIS approved STB only for IP TV service, FDI cap of 49%.
3. We support immediate amendment to the Downlinking Policy dated November 11, 2005 issued by the Ministry of I&B to permit Broadcasters to provide TV Channels to IPTV Service Providers in addition to MSOs, Cable Operators or DTH Operators.
4. We agree with the stand adopted by TRAI that IP TV content shall be regulated by Ministry of I&B, while transport network of Telecom Operator shall be regulated by DoT and transport network of Cable Operator shall continue to be governed by Ministry of I&B.

26. Zee Network

The conclusions have been presented as "fait accompli" rather than raising "issues for consultations" and arriving at the conclusions only after receiving and analyzing the response of stakeholders in the form of "recommendations".

We would further propose that the TRAI should publish the comments of all the stakeholders on the website and give at least a week before any public discussions and open house sessions.

Television network is designed to provide cable services for reception by multiple subscribers IPTV is a point to point and designed to deliver TV signals to individual subscribers rather than multiple subscribers. However, in Para 2.2 while discussing encoding it is specifically stated that IPTV is a "multicast" service which means nothing but delivery to multiple subscribers. Further in Para 3.12 it states that signals in IPTV are available in DSLAM, it may be noted that similar is the case in cable delivery where all the signals available at the headend (MSO) or at the control room. (Cable operator).

IPTV delivery uses the same optical fiber cable network which is used in cable service. IPTV also uses the copper which is equivalent to the coaxial cable used in cable service. IPTV sometimes uses wireless in the last mile which is something like DTH or MMDS which is a wireless service to the consumers in the last mile. In fact lot of cable operators are using wireless for the last mile delivery which in our view does not convert a cable service into a wireless service.

Cable operators providing IPTV services would be liable for any violation in the content code whereas a telecom provider providing the

same services would go scot free. This is discriminatory on the face of it.

Zee Network recommendations in regard to mode of delivery:

- (i) The intention of IPTV regulations should not be to obviate the extant regulations and allow an operator to create a parallel Satellite direct to home or terrestrial broadcasting network.
- (ii) The IPTV license agreement should specify the network types and mode of delivery.

Comments of Zee Network specifically relating to permitting only standards based IPTV for large scale customer deployment:

- (i) The IPTV services should only be permitted to be introduced through DVB-IP based standards rather than proprietary standards of any type.
- (ii) The TRAI should mandate the certification of IPTV boxes by the BIS as is the case for DTH STBs. The STB should have features such as parental control to prohibit viewing of illegitimate programs.
- (iii) All STBs should be certified by the BIS with respect to barring of Internet TV as the TRAI has already proposed that only the channels with downlink permissions are allowed. The Internet has over 3000 channels and these need to be barred as "Internet TV".
- (iv) The use of any proprietary technologies should be prohibited in the larger customer interest.
- (v) The Department of IT should be consulted on the potential harm from proprietary technologies as such networks are getting integrated into home networks.

The recommendations of the Zee Network in regard to the QoS are as follows:

- (i) TRAI should prescribe the QoS parameters for IPTV on lines of DTH before issuing the license terms and conditions for IPTV.
- (ii) The QoS parameters should specify inter-alia the minimum bit rates and resolution and frame rates at which the programs will be delivered.

The recommendations of the Zee Network in regard to on-demand content for IPTV networks before any licensing comes into effect are as follows:

- (i) TRAI should prepare a model agreement for on-demand content, which should inter-alia mention about the rights of the content owner who owns the IPRs (Such as Zee TV). It should also contain

a mention that the IPTV provider is aware of, and is bound to serve the content as per the rights granted for the territories of India or any other territories over which the broadcaster has granted the rights in writing.

- (ii) The rights granted to a viewer in a TV channel are only for viewing the channel live or storage on a PVR for personal viewing. The on demand content is quite different. It has further ramifications of the period for which such content can be stored, and the type of customers i.e. public exhibitors, theatre owners, video parlors can exhibit such content. Hence the model agreement should protect the broadcaster from unauthorized exhibition.
- (iii) Mandatory application of DRM to content: Worldwide, all on demand content is now being subject to DRM. A DRM restricts the viewer in how many times the content can be viewed, whether it can be copied or retransmitted. DRM 2.0 is now a global open standard for this purpose. At the stage, when the TRAI would undertake an exercise of stipulating the License conditions, it must incorporate the mandatory provision of DRM and watermarking on content to prevent the complete destruction of the entire pay TV video market. This is also in conformity to the WIPO for which MIB is the nodal ministry. We further suggest that before any regulation is issued by the TRAI, a reference should be made to the MIB for India's commitments under the WIPO for on demand content.
- (iv) Bouqueting of on demand content: The bouqueting of on demand content such as a cartoon series from different channels (or Bond movies culled from different channels) is another way of bundling of content. The TRAI should set proper regulations on on-demand content bouqueting, for incorporation in the Reference interconnect agreement.
- (v) The security requirements of IPTV should be aligned as per the **ITU standards**. (Annexure-2).

The recommendations of the Zee Network, with reference to the territorial coverage are as follows:

- (i) Before TRAI decides on any “must provide regulations” to any broadcaster, the TRAI must specify in the License clause for IPTV agreement that the services must be restricted to the agreed territories in the Model interconnect agreement.
- (ii) The broadcaster should have a right to audit the network and customer base to ensure that the service is being delivered in authorized areas only.

(iii) If there are any third party liabilities directly as a result of IPTV provider failing to adhere to the territories covered, it must be directly responsible for all third party damages.

The Zee Network would like to propose as follows in regard to the regulatory issues.

- (i) The IPTV service should be declared as a cable TV service and be subject to similar regulations, except that the VoD recommendations should be enacted separately.
- (ii) Wireless delivery of both IPTV and Cable TV should be permitted.
- (iii) **A new license agreement should be drafted which should reflect all the characteristics of IPTV as explained in our discussion.**

Zee Network recommendations on Content code for IPTV services:

TRAI needs to recognize the importance of content regulation code for online and on demand services, formulate direct implementable guidelines on the lines of DTH and Cable TV for IPTV services as well. It may follow the EU model or other model based on discussions with broadcasters and content providers.

27. Mr. Keshavamorthy K K

We should completely have a new look at the licensing methodology. Have a look at the following picture which describes my proposal

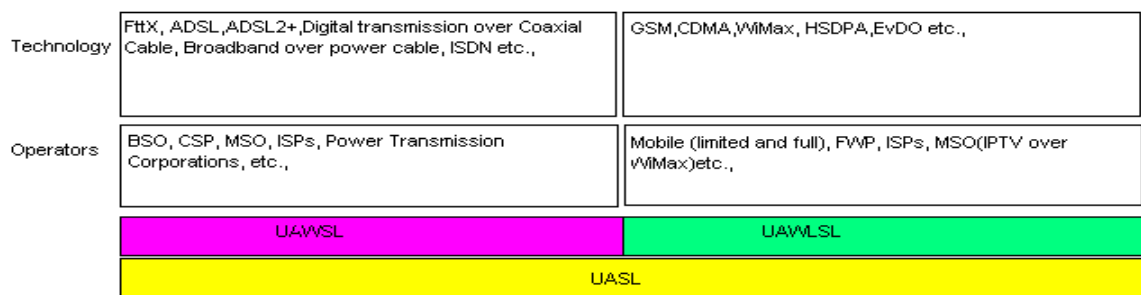

My suggestion would be to have 3 different licenses.

- 1)UASL → Unified Access Service License
- 2)UAWSL → Unified Access Wired Service License

3) UAWLSL → Unified Access Wire Less Service License

UASP can work on both wired and wireless medium.

All the current UASPs can continue to hold the license.

The current CSP (Cable Service Provider), MSO (Multi system operator), ISP(internet service provider) can be migrated to UAWSL on payment of certain entry fee.

Current wired ISPs or MSOs interested in WiMax can bid for UASL.

Advantages of this 2 tier approach

- 1) Wired and Wireless world are separated
- 2) Wireless license will be costly because of the spectrum crunch so service providers can get less costly UAWSL if their capex capacity is low.
- 3) New green field ISPs and MSOs who want to directly enter wireless market can only buy UAWLSL license instead of UASL.
- 4) Helps power transmission corporations to enter broadband business with cost effective UAWSL once broadband over power cable matures.
- 5) For UAWSL, we can completely remove roll out obligations since the medium is their own investment.
- 6) Only UAWLSL portion of UASL will have roll out obligation.
- 7) Since the license doesn't specify about the technology, operators will be in advantageous position to use any of the technology in that domain
- 8) For wireless domain the alternate technologies can be deployed subject to availability of the spectrum and paying the corresponding spectrum fee.
- 9) Any licensee in any domain is allowed to provide telephone, broadband and television without any further license.

Certainly just with current USAPs we cannot achieve expected broadband penetration. Its like Midsummer Night's Dream to depend on current USAPs for broadband penetration. They'll never going to change the attitude of cherry picking unless we induce further competition and lower their ARPUs.

ISPs and CSPs are fragmented and distributed nook and corner of India. Most of these are run by young and energetic entrepreneurs. We have to leverage upon these distributed ISPs and CSPs. This can only be achieved by promoting them to 'Triple Play' operators. The way to promote them is the way highlighted in the previous page.

Since the last mile is going to be very highly fragmented after the above said promotion, TRAI should ensure QoS in 'Triple Play' are met. TRAI should **publish** the QoS document which is very simple to understand and help to collect evidence which can withstand in the

court of law and doesn't include any very high technical vocabulary. This way the consumer even at the rural household can easily understand and bring the distributor to the court for less QoS.

TRAI should invest heavily on advertising the QoS so that each citizen is aware of his rights and be a regulator himself rather than depending on TRAI for everything.

While providing Internet services over IPTV, operator should only act as provider of the **pipe** and should not bother about the content. **Net neutrality** has to be maintained.

28. Mr. Mahesh Khera

Telcos, CMSPs and MSOs are continuously expanding the reach of their core and edge networks with their fiber reaching deeper and deeper in semi urban and rural areas. These service providers today are in a position to originate and carry the multi play (voice, broad band, TV, VoD, music, photos, games, lottery and Fixed Mobile Convergence (FMC)) signals as long and mid hauls.

LCOs are already ready with their much improved cable TV access to homes. At a meagre additional cost of around INR 200/- per home for a very slight upgrade in their network needed for digitalization and addressability, their last mile cable network can deliver the multi play signals to homes. What is missing is a very minor regulatory framework to voluntarily interconnect these two networks ie, the networks of telcos/CMSPs/MSOs and LCOs. Therefore, taking the lessons from telecom where interconnect regime has been successfully put in place, same needs to be done for multi play service on cable.

one decision of introducing very minor regulation for this interconnect will contribute immensely to health, education, medical and local self governance needs necessary to ensure that massive investment in infrastructure yields quicker returns. If voice and internet charges can be fixed for origination, carriage and distribution and it is made mandatory for both telcos/CMSPs/MSOs and LCOs to abide by the interconnect clauses where by neither will disconnect service to the subscribers.

29. Mr. P K Basak

India Telegraph Act: 1888 (with many amendments subsequently) is an umbrella-like generic legislation that covers both the services - telecom (2 ways) & broadcasting (1 way). Technologically IPTV is a kind of narrowcasting through cables but the content is all to do with TV & Video as in the broadcasting sector. It is the very essence & nature of services that should really determine where it should belong

to - not the means to deliver content, i.e. carriage.

The MI&B should set the IPTV service guidelines with the help of TRAI covering the aspects on carriage, wherever appropriate. From the consumers' perspective the IPTV service providers should thus be clearly into focus & held responsible & accountable wholly on delivery of services (like the DTH, CAS & non-CAS operators).